

Inspiron 15

7000 Series

Service Manual

Computer Model: Inspiron 15-7557
Regulatory Model: P57F
Regulatory Type: P57F001



Notes, cautions, and warnings



NOTE: A NOTE indicates important information that helps you make better use of your computer.



CAUTION: A CAUTION indicates either potential damage to hardware or loss of data and tells you how to avoid the problem.



WARNING: A WARNING indicates a potential for property damage, personal injury, or death.

Copyright © 2015 Dell Inc. All rights reserved. This product is protected by U.S. and international copyright and intellectual property laws. Dell™ and the Dell logo are trademarks of Dell Inc. in the United States and/or other jurisdictions. All other marks and names mentioned herein may be trademarks of their respective companies.

2015 - 07

Rev. A00

Contents

Before working inside your computer.....	9
Before you begin	9
Safety instructions.....	9
Recommended tools.....	11
After working inside your computer.....	12
Removing the base cover.....	13
Procedure.....	13
Replacing the base cover.....	14
Procedure.....	14
Removing the battery.....	15
Prerequisites.....	15
Procedure.....	15
Replacing the battery.....	17
Procedure.....	17
Post-requisites.....	17
Removing the memory modules.....	18
Prerequisites.....	18
Procedure.....	18
Replacing the memory modules.....	20
Procedure.....	20
Post-requisites.....	21

Removing the hard drive.....	22
Prerequisites.....	22
Procedure.....	22
Replacing the hard drive.....	25
Procedure.....	25
Post-requisites.....	25
Removing the wireless card.....	26
Prerequisites.....	26
Procedure.....	26
Replacing the wireless card.....	28
Procedure.....	28
Post-requisites.....	28
Removing the keyboard.....	29
Prerequisites.....	29
Procedure.....	29
Replacing the keyboard.....	32
Procedure.....	32
Post-requisites.....	32
Removing the palm rest.....	33
Prerequisites.....	33
Procedure.....	33
Replacing the palm rest.....	38
Procedure.....	38
Post-requisites.....	38

Removing the power-button board.....	39
Prerequisites.....	39
Procedure.....	39
Replacing the power-button board.....	41
Procedure.....	41
Post-requisites.....	41
Removing the coin-cell battery.....	42
Prerequisites.....	42
Procedure.....	42
Replacing the coin-cell battery.....	44
Procedure.....	44
Post-requisites.....	44
Removing the status-light board.....	45
Prerequisites.....	45
Procedure.....	45
Replacing the status-light board.....	47
Procedure.....	47
Post-requisites.....	47
Removing the fans.....	48
Prerequisites.....	48
Procedure.....	48
Replacing the fans.....	51
Procedure.....	51
Post-requisites.....	51

Removing the I/O board.....	52
Prerequisites.....	52
Procedure.....	52
Replacing the I/O board.....	54
Procedure.....	54
Post-requisites.....	54
Removing the system board.....	55
Prerequisites.....	55
Procedure.....	55
Replacing the system board.....	59
Procedure.....	59
Post-requisites.....	59
Entering the Service Tag in the BIOS setup program.....	60
Removing the heat sink.....	61
Prerequisites.....	61
Procedure.....	61
Replacing the heat sink.....	63
Procedure.....	63
Post-requisites.....	63
Removing the speakers.....	64
Prerequisites.....	64
Procedure.....	64
Replacing the speakers.....	66
Procedure.....	66
Post-requisites.....	66

Removing the subwoofer.....	67
Prerequisites.....	67
Procedure.....	67
Replacing the subwoofer.....	69
Procedure.....	69
Post-requisites.....	69
Removing the power-adapter port.....	70
Prerequisites.....	70
Procedure.....	70
Replacing the power-adapter port.....	73
Procedure.....	73
Post-requisites.....	73
Removing the display assembly.....	74
Prerequisites.....	74
Procedure.....	74
Replacing the display assembly.....	77
Procedure.....	77
Post-requisites.....	77
Removing the display bezel.....	78
Prerequisites.....	78
Procedure.....	78
Replacing the display bezel.....	80
Procedure.....	80
Post-requisites.....	80



Removing the display panel.....	81
Prerequisites.....	81
Procedure.....	82
Replacing the display panel.....	84
Procedure.....	84
Post-requisites.....	84
Removing the display hinge and bracket assembly.....	85
Prerequisites.....	85
Procedure.....	85
Replacing the display hinge and bracket assembly.....	87
Procedure.....	87
Post-requisites.....	87
Removing the camera.....	88
Prerequisites.....	88
Procedure.....	88
Replacing the camera.....	90
Procedure.....	90
Post-requisites.....	90
Flashing the BIOS.....	91
Getting help and contacting Dell.....	92
Self-help resources.....	92
Contacting Dell.....	93

Before working inside your computer

 **CAUTION:** To avoid damaging the components and cards, handle them by their edges and avoid touching pins and contacts.









 **NOTE:** The images in this document may differ from your computer depending on the configuration you ordered.

Before you begin

- 1 Save and close all open files and exit all open applications.
 - 2 Shut down your computer.
 - Windows 10: Click or tap **Start** →  **Power** → **Shut down**.
 - Windows 8.1: On the **Start** screen, click or tap the power icon  → **Shut down**.
 - Windows 7: Click or tap **Start** → **Shut down**.
-  **NOTE:** If you are using a different operating system, see the documentation of your operating system for shut-down instructions.
- 3 Disconnect your computer and all attached devices from their electrical outlets.
 - 4 Disconnect all cables such as telephone cables, network cables and so on, from your computer.
 - 5 Disconnect all attached devices and peripherals, such as keyboard, mouse, monitor, and so on, from your computer.
 - 6 Remove any media card and optical disc from your computer, if applicable.

Safety instructions

Use the following safety guidelines to protect your computer from potential damage and ensure your personal safety.

-  **WARNING:** Before working inside your computer, read the safety information that shipped with your computer. For more safety best practices, see the Regulatory Compliance home page at www.dell.com/regulatory_compliance.
-  **WARNING:** Disconnect all power sources before opening the computer cover or panels. After you finish working inside the computer, replace all covers, panels, and screws before connecting to the power source.
-  **CAUTION:** To avoid damaging the computer, ensure that the work surface is flat and clean.
-  **CAUTION:** To avoid damaging the components and cards, handle them by their edges and avoid touching pins and contacts.
-  **CAUTION:** You should only perform troubleshooting and repairs as authorized or directed by the Dell technical assistance team. Damage due to servicing that is not authorized by Dell is not covered by your warranty. See the safety instructions that shipped with the product or at www.dell.com/regulatory_compliance.
-  **CAUTION:** Before touching anything inside your computer, ground yourself by touching an unpainted metal surface, such as the metal at the back of the computer. While you work, periodically touch an unpainted metal surface to dissipate static electricity, which could harm internal components.
-  **CAUTION:** When you disconnect a cable, pull on its connector or on its pull tab, not on the cable itself. Some cables have connectors with locking tabs or thumb-screws that you must disengage before disconnecting the cable. When disconnecting cables, keep them evenly aligned to avoid bending any connector pins. When connecting cables, ensure that the ports and connectors are correctly oriented and aligned.
-  **CAUTION:** Press and eject any installed card from the media-card reader.

Recommended tools

The procedures in this document may require the following tools:

- Philips screwdriver
- Torx #8 (T8) screwdriver
- Plastic scribe

After working inside your computer



CAUTION: Leaving stray or loose screws inside your computer may severely damage your computer.

- 1 Replace all screws and ensure that no stray screws remain inside your computer.
- 2 Connect any external devices, peripherals, and cables you removed before working on your computer.
- 3 Replace any media cards, discs, and any other parts that you removed before working on your computer.
- 4 Connect your computer and all attached devices to their electrical outlets.
- 5 Turn on your computer.

Removing the base cover

 **WARNING:** Before working inside your computer, read the safety information that shipped with your computer and follow the steps in [Before working inside your computer](#). After working inside your computer, follow the instructions in [After working inside your computer](#). For more safety best practices, see the Regulatory Compliance home page at www.dell.com/regulatory_compliance.

Procedure

- 1 Close the display and turn the computer over.
- 2 Loosen the captive screw that secures the base cover to the computer base.
- 3 Using a plastic scribe, pry the base cover off the computer base.

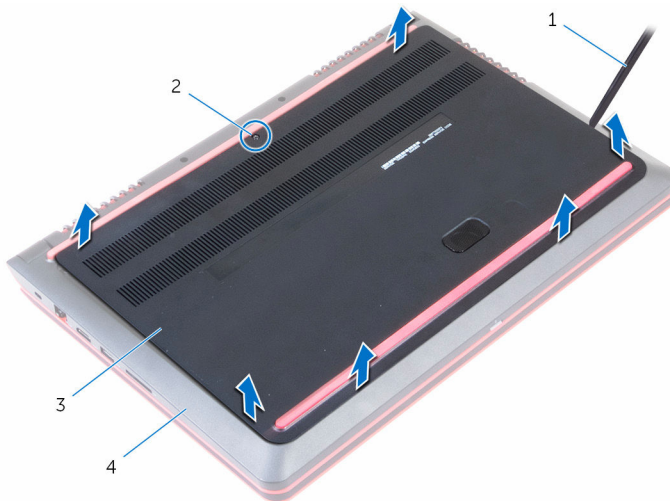

- | | | | |
|---|----------------|---|---------------|
| 1 | plastic scribe | 2 | captive screw |
| 3 | base cover | 4 | computer base |

Replacing the base cover



WARNING: Before working inside your computer, read the safety information that shipped with your computer and follow the steps in [Before working inside your computer](#). After working inside your computer, follow the instructions in [After working inside your computer](#). For more safety best practices, see the Regulatory Compliance home page at www.dell.com/regulatory_compliance.

Procedure

- 1 Slide the tabs on the base cover into the slots on the computer base and snap the base cover into place.
- 2 Tighten the captive screw that secures the base cover to the computer base.

Removing the battery

⚠ WARNING: Before working inside your computer, read the safety information that shipped with your computer and follow the steps in [Before working inside your computer](#). After working inside your computer, follow the instructions in [After working inside your computer](#). For more safety best practices, see the Regulatory Compliance home page at www.dell.com/regulatory_compliance.

Prerequisites

Remove the [base cover](#).

Procedure

- 1 Disconnect the battery cable from the system board.
- 2 Remove the screws that secure the battery to the computer base.

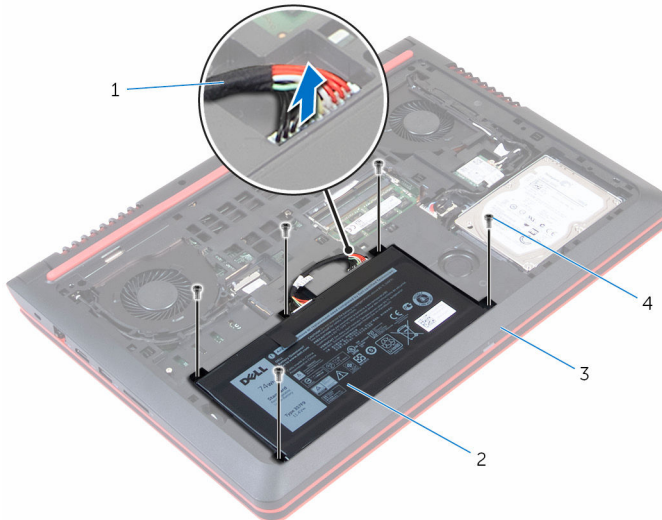

- | | | | |
|---|---------------|---|-------------------|
| 1 | battery cable | 2 | battery |
| 3 | computer base | 4 | Trox-8 screws (5) |

- 3** Using the pull tab, lift the battery, along with its cable, out of the computer base.

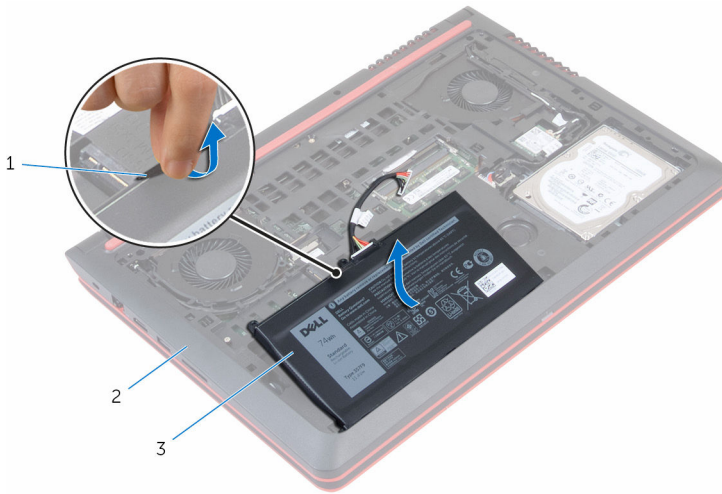

1 pull tab

2 computer base

3 battery

- 4** Turn the computer over, open the display, and press the power button for five seconds to ground the system board.

Replacing the battery



WARNING: Before working inside your computer, read the safety information that shipped with your computer and follow the steps in [Before working inside your computer](#). After working inside your computer, follow the instructions in [After working inside your computer](#). For more safety best practices, see the Regulatory Compliance home page at www.dell.com/regulatory_compliance.

Procedure

- 1 Align the screw holes on the battery with the screw holes on the computer base.
- 2 Replace the screws that secure the battery to the computer base.
- 3 Connect the battery cable to the system board.
- 4 Turn the computer over and open the display as far as possible.

Post-requisites

Replace the [base cover](#).

Removing the memory modules

 **WARNING:** Before working inside your computer, read the safety information that shipped with your computer and follow the steps in [Before working inside your computer](#). After working inside your computer, follow the instructions in [After working inside your computer](#). For more safety best practices, see the Regulatory Compliance home page at www.dell.com/regulatory_compliance.

Prerequisites

- 1 Remove the [base cover](#).
- 2 Remove the [battery](#).

Procedure

- 1 Use your fingertips to carefully spread apart the securing-clips on each end of the memory-module slot until the memory module pops up.

2 Slide and remove the memory module from the memory-module slot.

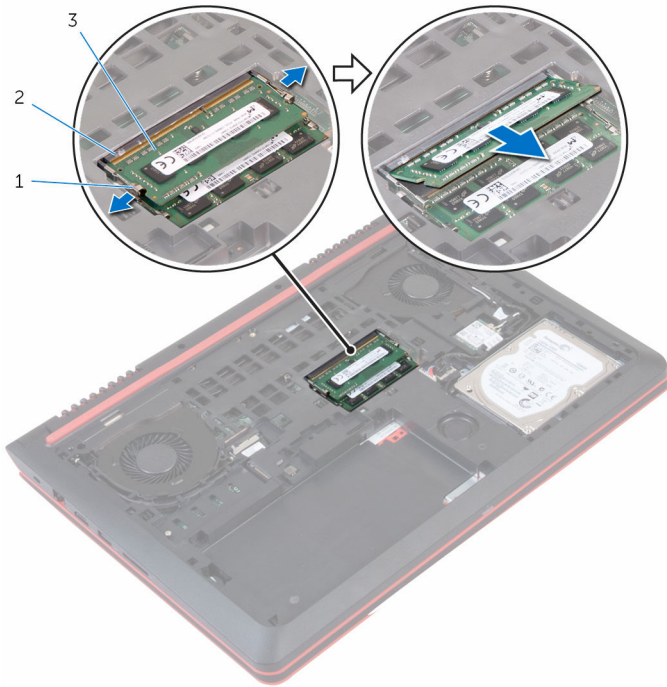

1 securing clips (2)

2 memory-module slot

3 memory module

Replacing the memory modules

 **WARNING:** Before working inside your computer, read the safety information that shipped with your computer and follow the steps in [Before working inside your computer](#). After working inside your computer, follow the instructions in [After working inside your computer](#). For more safety best practices, see the Regulatory Compliance home page at www.dell.com/regulatory_compliance.

Procedure

- 1 Align the notch on the memory module with the tab on the memory-module slot.

- Slide the memory module firmly into the slot at an angle and press the memory module down until it clicks into place.

 **NOTE:** If you do not hear the click, remove the memory module and reinstall it.

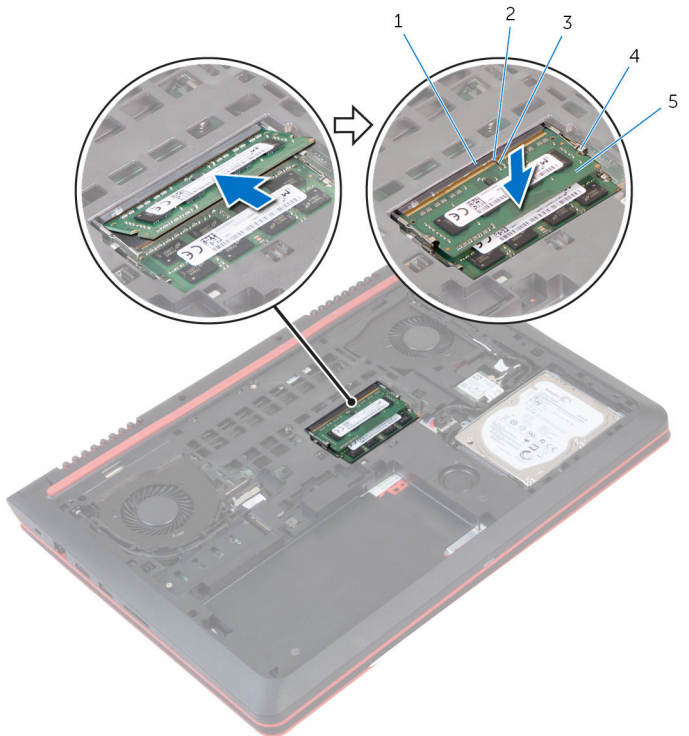

- slot
- notch
- memory module

- tab
- securing clips (2)

Post-requisites

- Replace the [battery](#).
- Replace the [base cover](#).

Removing the hard drive

 **WARNING:** Before working inside your computer, read the safety information that shipped with your computer and follow the steps in [Before working inside your computer](#). After working inside your computer, follow the instructions in [After working inside your computer](#). For more safety best practices, see the Regulatory Compliance home page at www.dell.com/regulatory_compliance.

 **CAUTION:** Hard drives are fragile. Exercise care when handling the hard drive.

 **CAUTION:** To avoid data loss, do not remove the hard drive while the computer is in sleep or on state.

Prerequisites

- 1 Remove the [battery](#).
- 2 Remove the [base cover](#).

Procedure

- 1 Remove the screws that secure the hard-drive assembly to the computer base.
- 2 Using the pull-tab, disconnect the hard-drive cable from the system board.

3 Lift the hard-drive assembly off the computer base.

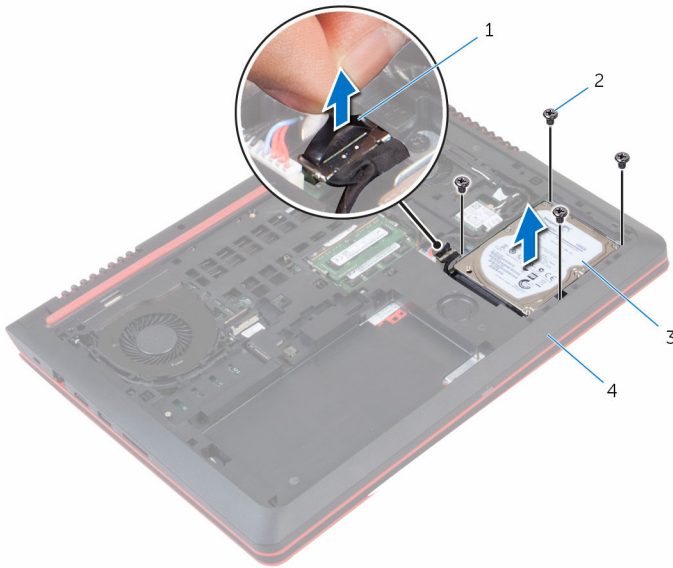

1 pull-tab

2 screws (4)

3 hard-drive assembly

4 computer base

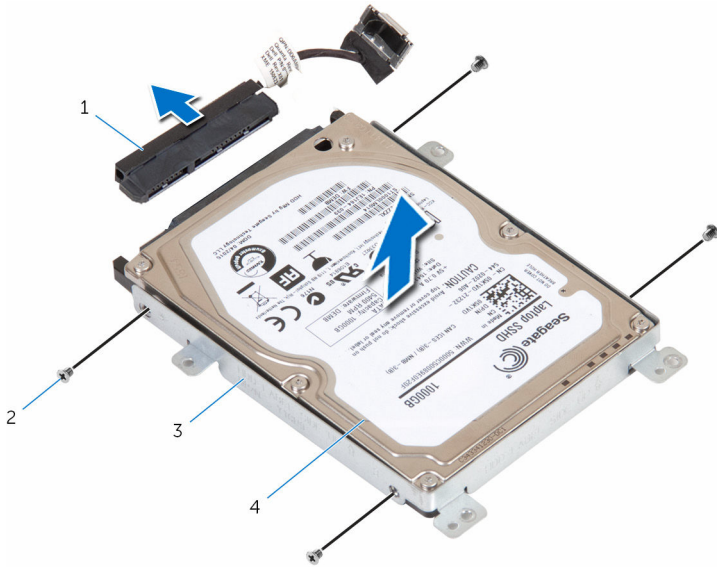

4 Disconnect the interposer from the hard drive.

- 5 Remove the screws that secure the hard-drive bracket to the hard drive and lift the bracket off the hard drive.



- | | | | |
|---|--------------------|---|------------|
| 1 | interposer | 2 | screws (4) |
| 3 | hard-drive bracket | 4 | hard drive |

Replacing the hard drive

-  **WARNING:** Before working inside your computer, read the safety information that shipped with your computer and follow the steps in [Before working inside your computer](#). After working inside your computer, follow the instructions in [After working inside your computer](#). For more safety best practices, see the Regulatory Compliance home page at www.dell.com/regulatory_compliance.
-  **CAUTION:** Hard drives are fragile. Exercise care when handling the hard drive.

Procedure

- 1 Align the screw holes on the hard-drive bracket with the screw holes on the hard drive.
- 2 Replace the screws that secure the hard-drive bracket to the hard drive.
- 3 Connect the interposer to the hard-drive assembly.
- 4 Align the screw holes on the hard-drive assembly with the screw holes on the computer base.
- 5 Replace the screws that secure the hard-drive assembly to the computer base.
- 6 Connect the hard-drive cable to the system board.

Post-requisites

- 1 Replace the [base cover](#).
- 2 Replace the [battery](#).

Removing the wireless card



WARNING: Before working inside your computer, read the safety information that shipped with your computer and follow the steps in [Before working inside your computer](#). After working inside your computer, follow the instructions in [After working inside your computer](#). For more safety best practices, see the Regulatory Compliance home page at www.dell.com/regulatory_compliance.

Prerequisites

- 1 Remove the [base cover](#).
- 2 Remove the [battery](#).

Procedure

- 1 Disconnect the antenna cables from the wireless card.
- 2 Remove the screw that secures the wireless card to the system board.

3 Slide and remove the wireless card out of the wireless-card slot.

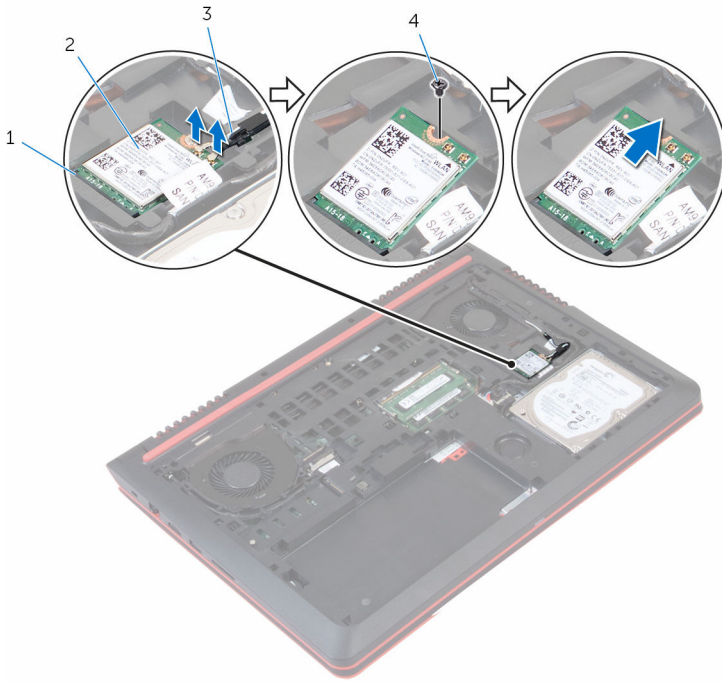

- 1 wireless-card slot
- 3 antenna cables (2)

- 2 wireless card
- 4 screw

Replacing the wireless card

 **WARNING:** Before working inside your computer, read the safety information that shipped with your computer and follow the steps in [Before working inside your computer](#). After working inside your computer, follow the instructions in [After working inside your computer](#). For more safety best practices, see the Regulatory Compliance home page at www.dell.com/regulatory_compliance.

Procedure

 **CAUTION:** To avoid damage to the wireless card, do not place any cables under it.

- 1 Align the notch on the wireless card with the tab on the wireless-card slot.
- 2 Insert the wireless card into the wireless-card slot.
- 3 Replace the screw that secures the wireless card to the system board.
- 4 Connect the antenna cables to the wireless card.

The following table provides the antenna-cable color scheme for the wireless card supported by your computer.

Connectors on the wireless card	Antenna-cable color
Main (white triangle)	white
Auxiliary (black triangle)	black

Post-requisites

- 1 Replace the [battery](#).
- 2 Replace the [base cover](#).

Removing the keyboard



WARNING: Before working inside your computer, read the safety information that shipped with your computer and follow the steps in [Before working inside your computer](#). After working inside your computer, follow the instructions in [After working inside your computer](#). For more safety best practices, see the Regulatory Compliance home page at www.dell.com/regulatory_compliance.

Prerequisites

Remove the [battery](#).

Procedure

- 1 Turn the computer over and open the display as far as possible.
- 2 Using a plastic scribe, gently release the tabs that secure the keyboard to the palm-rest assembly.

3 Carefully turn the keyboard over and place it on the palm-rest assembly.

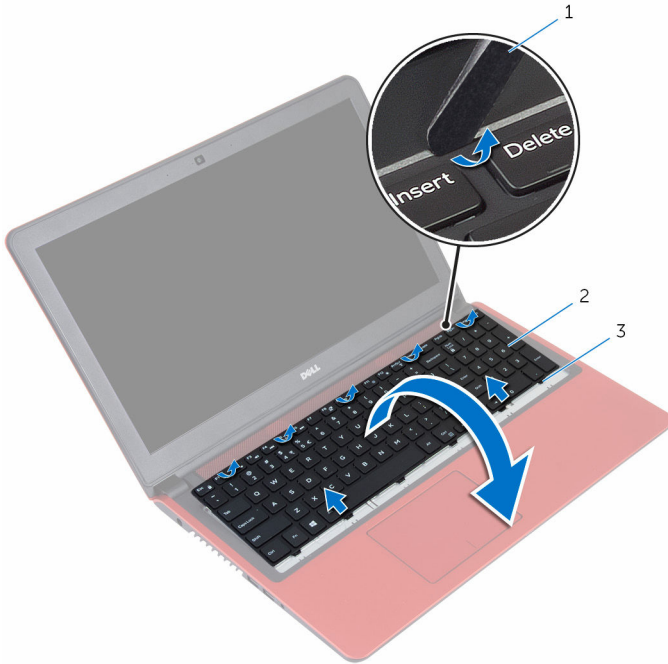

1 plastic scribe

2 keyboard

3 tabs (6)

- 4 Open the latches and disconnect the keyboard cable and the keyboard-backlight cable from the system board.

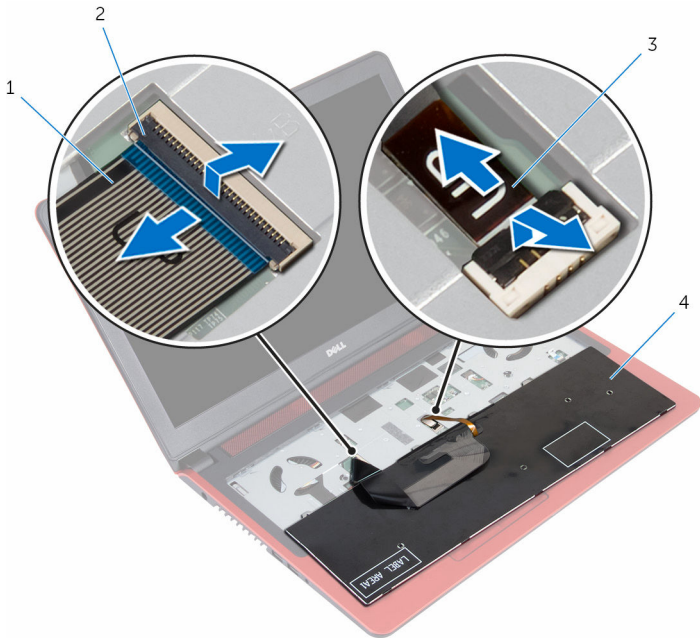

- | | | | |
|---|--------------------------|---|-------------|
| 1 | keyboard cable | 2 | latches (2) |
| 3 | keyboard-backlight cable | 4 | keyboard |

- 5 Lift the keyboard, along with the cables, off the palm-rest assembly.

Replacing the keyboard



WARNING: Before working inside your computer, read the safety information that shipped with your computer and follow the steps in [Before working inside your computer](#). After working inside your computer, follow the instructions in [After working inside your computer](#). For more safety best practices, see the Regulatory Compliance home page at www.dell.com/regulatory_compliance.

Procedure

- 1 Slide the keyboard cable and keyboard-backlight cable into their connectors and close the latches to secure the cables.
- 2 Carefully turn the keyboard over, slide the tabs on the keyboard into the slots on the palm rest, and snap the keyboard into place.
- 3 Close the display and turn the computer over.

Post-requisites

Replace the [battery](#).

Removing the palm rest



WARNING: Before working inside your computer, read the safety information that shipped with your computer and follow the steps in [Before working inside your computer](#). After working inside your computer, follow the instructions in [After working inside your computer](#). For more safety best practices, see the Regulatory Compliance home page at www.dell.com/regulatory_compliance.

Prerequisites

- 1 Remove the [base cover](#).
- 2 Remove the [battery](#).
- 3 Follow the procedure from step 1 to step 3 in "[Removing the hard drive](#)".
- 4 Remove the [keyboard](#).

Procedure

- 1 Open the latches and disconnect the touch-pad cable and power-button cable from the system board.

- 2** Remove the screws that secure the palm-rest assembly to the computer base.

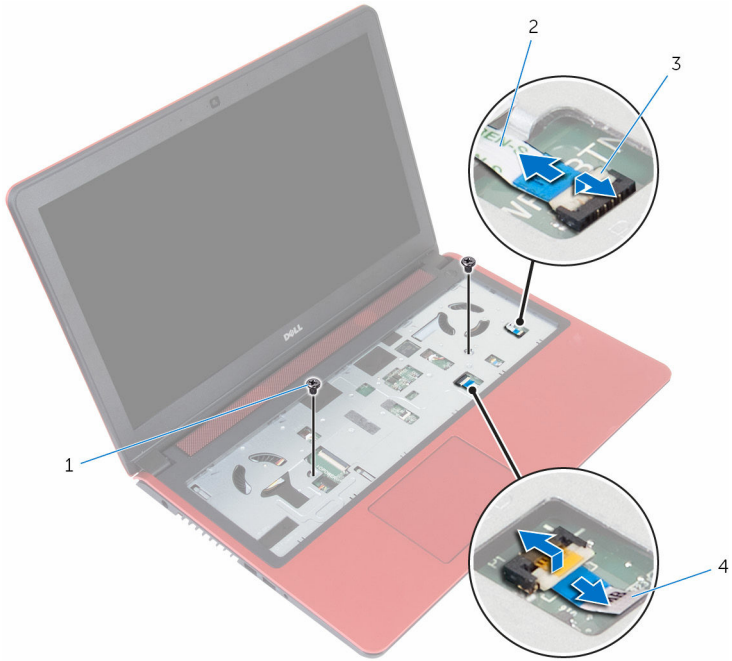

1 screws (2)

3 latches (2)

2 power-button cable

4 touch-pad cable

- 3** Close the display and turn the computer over.

- 4 Remove the screws that secure the palm-rest assembly to the computer base.

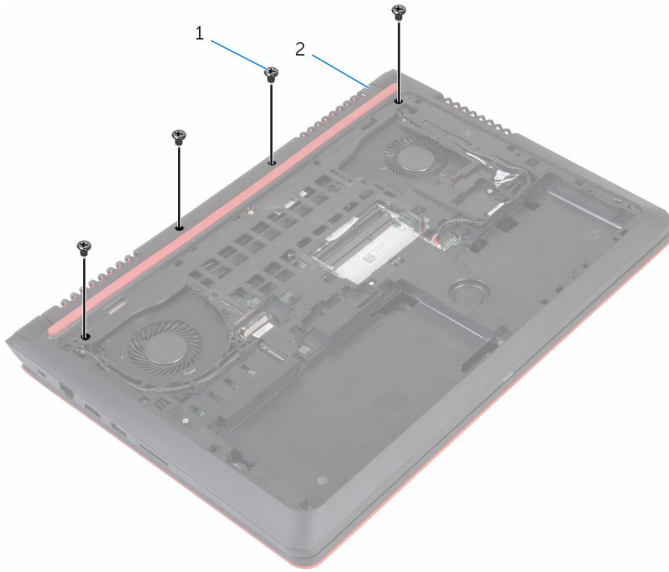

1 screws (4)

2 computer base

- 5 Lift the computer base and, using a plastic scribe, release the palm-rest assembly from the computer base

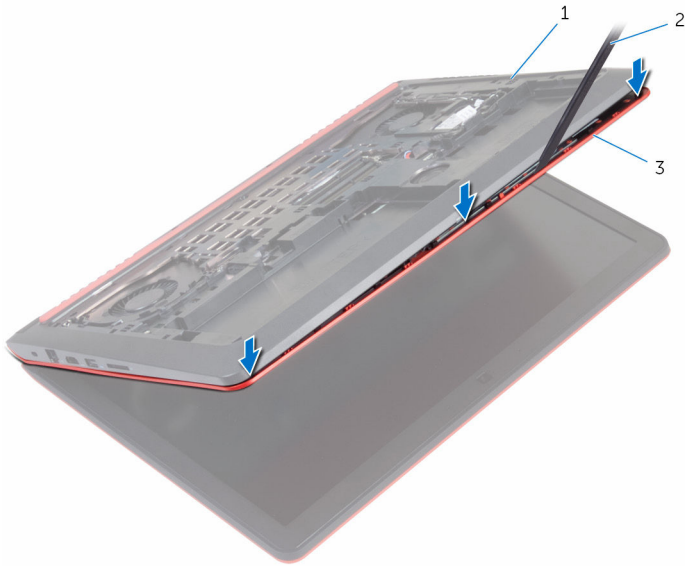

1 computer base

2 plastic scribe

3 palm rest

- 6 Turn the computer over and open the display.

- 7 Lift the palm-rest assembly off the computer base.

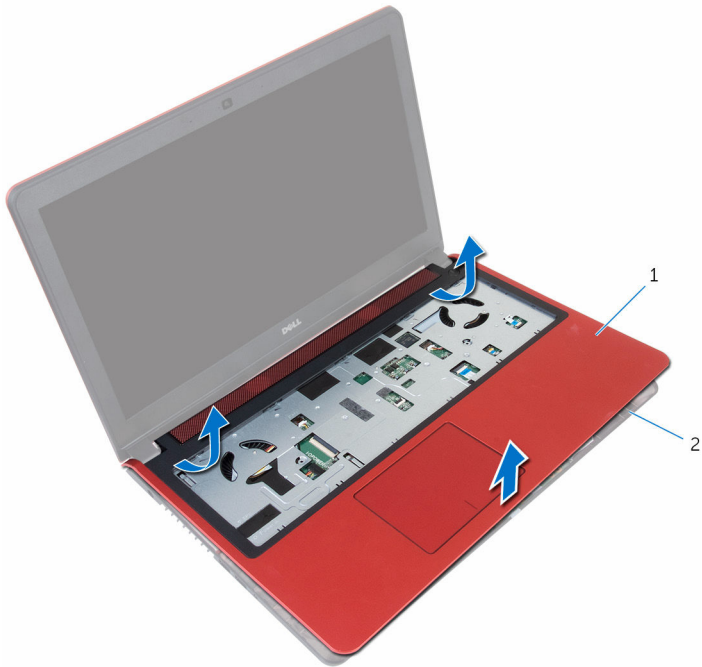

1 palm rest

2 computer base

- 8 Remove the [power-button board](#).

Replacing the palm rest



WARNING: Before working inside your computer, read the safety information that shipped with your computer and follow the steps in [Before working inside your computer](#). After working inside your computer, follow the instructions in [After working inside your computer](#). For more safety best practices, see the Regulatory Compliance home page at www.dell.com/regulatory_compliance.

Procedure

- 1 Replace the [power-button board](#).
- 2 Align the screw holes on the palm rest with the screw holes on the computer base and snap the palm rest into place.
- 3 Replace the screws that secure the palm rest to the computer base.
- 4 Slide the touch-pad cable and power-button cable into the connectors and close the latches to secure the cables.
- 5 Close the display and turn the computer over.
- 6 Replace the screws that secure the palm rest to the computer base.

Post-requisites

- 1 Replace the [keyboard](#).
- 2 Follow the procedure from step 4 to step 6 in "[Replacing the hard drive](#)".
- 3 Replace the [battery](#).
- 4 Replace the [base cover](#).

Removing the power-button board



WARNING: Before working inside your computer, read the safety information that shipped with your computer and follow the steps in [Before working inside your computer](#). After working inside your computer, follow the instructions in [After working inside your computer](#). For more safety best practices, see the Regulatory Compliance home page at www.dell.com/regulatory_compliance.

Prerequisites

- 1 Remove the [base cover](#).
- 2 Remove the [battery](#).
- 3 Follow the procedure from step 1 to step 3 in "[Removing the hard drive](#)".
- 4 Remove the [keyboard](#).
- 5 Follow the procedure from step 1 to step 7 in "[Removing the palm rest](#)".

Procedure

- 1 Open the latch and disconnect the power-button cable from the power button board.

2 Lift the power button board off the palm rest.

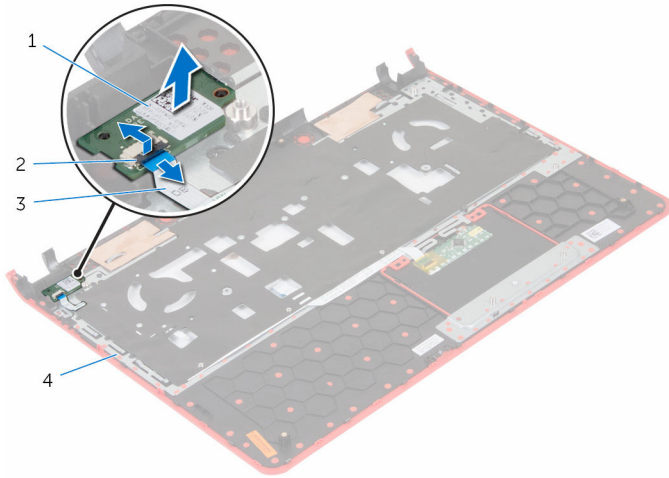

1 power button board

2 latch

3 power-button cable

4 palm rest

Replacing the power-button board



WARNING: Before working inside your computer, read the safety information that shipped with your computer and follow the steps in [Before working inside your computer](#). After working inside your computer, follow the instructions in [After working inside your computer](#). For more safety best practices, see the Regulatory Compliance home page at www.dell.com/regulatory_compliance.

Procedure

- 1 Place the power button board in the slot on the palm rest.
- 2 Slide the power-button cable into its connector on the power button board and close the latch to secure the cable.

Post-requisites

- 1 Follow the procedure from step 2 to step 6 in "[Replacing the palm rest](#)".
- 2 Replace the [keyboard](#).
- 3 Follow the procedure from step 4 to step 6 in "[Replacing the hard drive](#)".
- 4 Replace the [battery](#).
- 5 Replace the [base cover](#).

Removing the coin-cell battery

 **WARNING:** Before working inside your computer, read the safety information that shipped with your computer and follow the steps in [Before working inside your computer](#). After working inside your computer, follow the instructions in [After working inside your computer](#). For more safety best practices, see the Regulatory Compliance home page at www.dell.com/regulatory_compliance.

 **CAUTION:** Removing the coin-cell battery resets the BIOS setup program's settings to default. It is recommended that you note the BIOS setup program's settings before removing the coin-cell battery.

Prerequisites

- 1 Remove the [base cover](#).
- 2 Remove the [battery](#).
- 3 Follow the procedure from step 1 to step 3 in "[Removing the hard drive](#)".
- 4 Remove the [keyboard](#).
- 5 Follow the procedure from step 1 to step 7 in "[Removing the palm rest](#)".

Procedure

- 1 Disconnect the coin-cell battery cable from the system board.

- 2 Using a plastic scribe, gently pry the coin-cell battery out of the battery socket on the computer base.

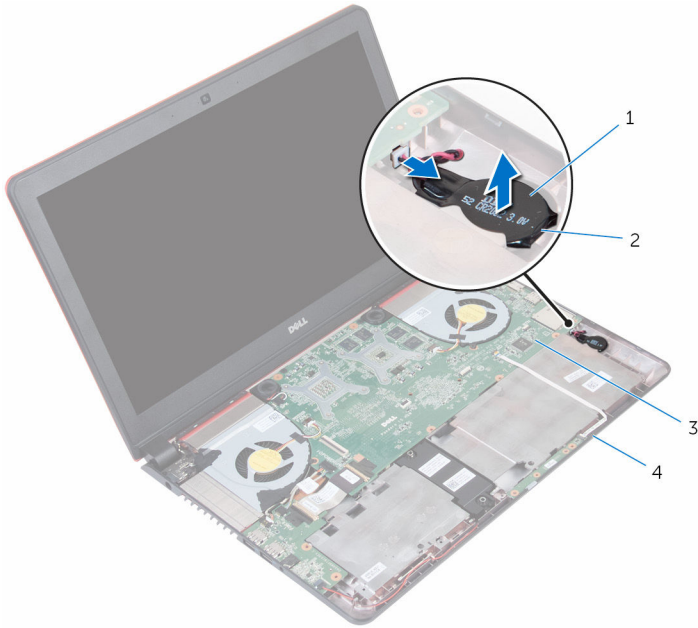

1 coin-cell battery

2 battery socket

3 system board

4 computer base

Replacing the coin-cell battery



WARNING: Before working inside your computer, read the safety information that shipped with your computer and follow the steps in [Before working inside your computer](#). After working inside your computer, follow the instructions in [After working inside your computer](#). For more safety best practices, see the Regulatory Compliance home page at www.dell.com/regulatory_compliance.

Procedure

- 1 With the positive-side facing up, snap the coin-cell battery into the battery socket on the computer base.
- 2 Connect the coin-cell battery cable to the system board.

Post-requisites

- 1 Follow the procedure from step 2 to step 6 in "[Replacing the palm rest](#)".
- 2 Replace the [keyboard](#).
- 3 Follow the procedure from step 4 to step 6 in "[Replacing the hard drive](#)".
- 4 Replace the [battery](#).
- 5 Replace the [base cover](#).

Removing the status-light board

 **WARNING:** Before working inside your computer, read the safety information that shipped with your computer and follow the steps in [Before working inside your computer](#). After working inside your computer, follow the instructions in [After working inside your computer](#). For more safety best practices, see the Regulatory Compliance home page at www.dell.com/regulatory_compliance.

Prerequisites

- 1 Remove the [base cover](#).
- 2 Remove the [battery](#).
- 3 Follow the procedure from step 1 to step 3 in "[Removing the hard drive](#)".
- 4 Remove the [keyboard](#).
- 5 Follow the procedure from step 1 to step 7 in "[Removing the palm rest](#)".

Procedure

- 1 Open the latch and disconnect the status-light board cable from the status light board.

2 Lift the status light board off the computer base.

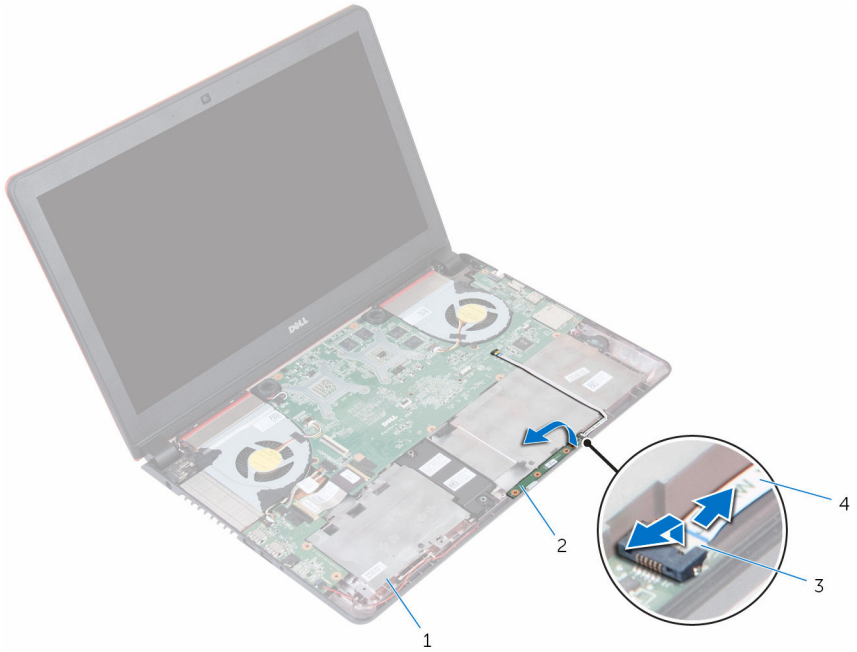

1 computer base

2 status light board

3 latch

4 status-light board cable

Replacing the status-light board



WARNING: Before working inside your computer, read the safety information that shipped with your computer and follow the steps in [Before working inside your computer](#). After working inside your computer, follow the instructions in [After working inside your computer](#). For more safety best practices, see the Regulatory Compliance home page at www.dell.com/regulatory_compliance.

Procedure

- 1 Place the status-light board in the slot on the computer base.
- 2 Slide the status-light board cable into the connector on the status light board and close the latch to secure the cable.

Post-requisites

- 1 Follow the procedure from step 2 to step 6 in "[Replacing the palm rest](#)".
- 2 Replace the [keyboard](#).
- 3 Follow the procedure from step 4 to step 6 in "[Replacing the hard drive](#)".
- 4 Replace the [battery](#).
- 5 Replace the [base cover](#).

Removing the fans



WARNING: Before working inside your computer, read the safety information that shipped with your computer and follow the steps in [Before working inside your computer](#). After working inside your computer, follow the instructions in [After working inside your computer](#). For more safety best practices, see the Regulatory Compliance home page at www.dell.com/regulatory_compliance.

Prerequisites

- 1 Remove the [base cover](#).
- 2 Remove the [battery](#).
- 3 Follow the procedure from step 1 to step 3 in "[Removing the hard drive](#)".
- 4 Remove the [keyboard](#).
- 5 Follow the procedure from step 1 to step 7 in "[Removing the palm rest](#)".

Procedure

- 1 Disconnect the left-fan cable from the system board.
- 2 Remove the I/O-board power cables from the routing guides on the left fan.

- 3** Lift the left fan along with its cable off the computer base.

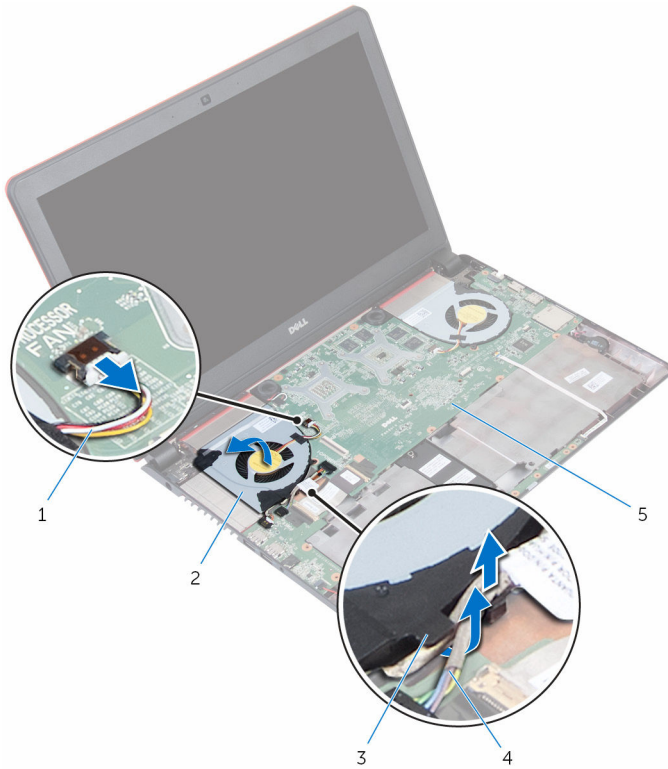

- | | | | |
|---|----------------|---|------------------------|
| 1 | fan cable | 2 | left fan |
| 3 | routing guides | 4 | I/O-board power cables |
| 5 | system board | | |

- 4** Disconnect the right-fan cable from the system board.

5 Lift the right-fan along with its cable off the computer base.

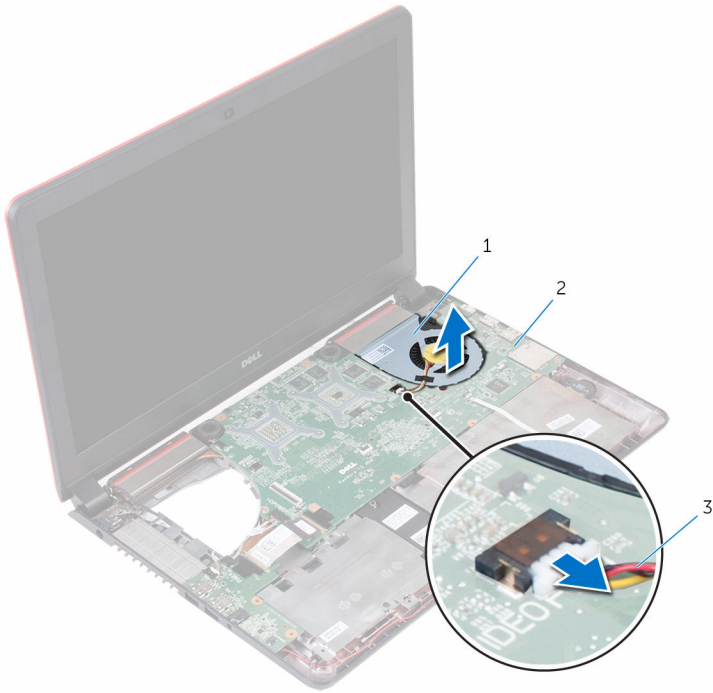

1 right fan

2 system board

3 fan cable

Replacing the fans



WARNING: Before working inside your computer, read the safety information that shipped with your computer and follow the steps in [Before working inside your computer](#). After working inside your computer, follow the instructions in [After working inside your computer](#). For more safety best practices, see the Regulatory Compliance home page at www.dell.com/regulatory_compliance.

Procedure

- 1 Using the alignment posts, place the right fan on the computer base.
- 2 Connect the right-fan cable to the system board.
- 3 Using the alignment posts, place the left fan on the computer base.
- 4 Route the I/O-board power cables through the routing guides on the left fan.
- 5 Connect the left-fan cable to the system board.

Post-requisites

- 1 Follow the procedure from step 2 to step 6 in "[Replacing the palm rest](#)".
- 2 Replace the [keyboard](#).
- 3 Follow the procedure from step 4 to step 6 in "[Replacing the hard drive](#)".
- 4 Replace the [battery](#).
- 5 Replace the [base cover](#).

Removing the I/O board



WARNING: Before working inside your computer, read the safety information that shipped with your computer and follow the steps in [Before working inside your computer](#). After working inside your computer, follow the instructions in [After working inside your computer](#). For more safety best practices, see the Regulatory Compliance home page at www.dell.com/regulatory_compliance.

Prerequisites

- 1 Remove the [base cover](#).
- 2 Remove the [battery](#).
- 3 Follow the procedure from step 1 to step 3 in "[Removing the hard drive](#)".
- 4 Remove the [keyboard](#).
- 5 Follow the procedure from step 1 to step 7 in "[Removing the palm rest](#)".

Procedure

- 1 Disconnect the I/O-board power cables from the I/O board.
- 2 Open the latch and disconnect the I/O-board cable from the I/O board.
- 3 Disconnect the sub-woofer cable from the I/O board.

4 Lift the I/O board off the computer base.

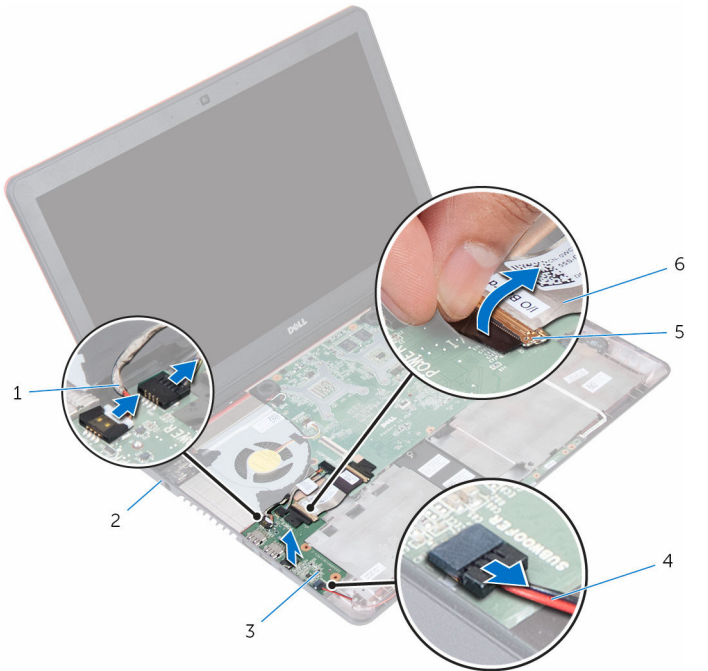

- | | | | |
|---|----------------------------|---|------------------|
| 1 | I/O-board power cables (2) | 2 | computer base |
| 3 | I/O board | 4 | sub-woofer cable |
| 5 | latch | 6 | I/O-board cable |

Replacing the I/O board



WARNING: Before working inside your computer, read the safety information that shipped with your computer and follow the steps in [Before working inside your computer](#). After working inside your computer, follow the instructions in [After working inside your computer](#). For more safety best practices, see the Regulatory Compliance home page at www.dell.com/regulatory_compliance.

Procedure

- 1 Align and place the I/O-board on the computer base.
- 2 Slide the I/O-board cable into its connector on the I/O board and close the latch to secure the cable.
- 3 Connect the I/O-board power cables and sub-woofer cable to the I/O board.

Post-requisites

- 1 Follow the procedure from step 2 to step 6 in "[Replacing the palm rest](#)".
- 2 Replace the [keyboard](#).
- 3 Follow the procedure from step 4 to step 6 in "[Replacing the hard drive](#)".
- 4 Replace the [battery](#).
- 5 Replace the [base cover](#).

Removing the system board



WARNING: Before working inside your computer, read the safety information that shipped with your computer and follow the steps in [Before working inside your computer](#). After working inside your computer, follow the instructions in [After working inside your computer](#). For more safety best practices, see the Regulatory Compliance home page at www.dell.com/regulatory_compliance.



NOTE: Your computer's Service Tag is stored in the system board. You must enter the Service Tag in the BIOS setup program after you replace the system board.



NOTE: Replacing the system board removes any changes you have made to the BIOS using the BIOS setup program. You must make the desired changes again after you replace the system board.



NOTE: Before disconnecting the cables from the system board, note the location of the connectors so that you can reconnect the cables correctly after you replace the system board.

Prerequisites

- 1 Remove the [base cover](#).
- 2 Remove the [battery](#).
- 3 Follow the procedure from step 1 to step 3 in "[Removing the hard drive](#)".
- 4 Remove the [memory modules](#).
- 5 Remove the [wireless card](#).
- 6 Remove the [keyboard](#).
- 7 Follow the procedure from step 1 to step 7 in "[Removing the palm rest](#)".
- 8 Remove the [I/O board](#).
- 9 Remove the [fans](#).

Procedure

- 1 Using the pull tab, disconnect the display cable from the system board.

- 2 Disconnect the power-adapter port cable from the system board.

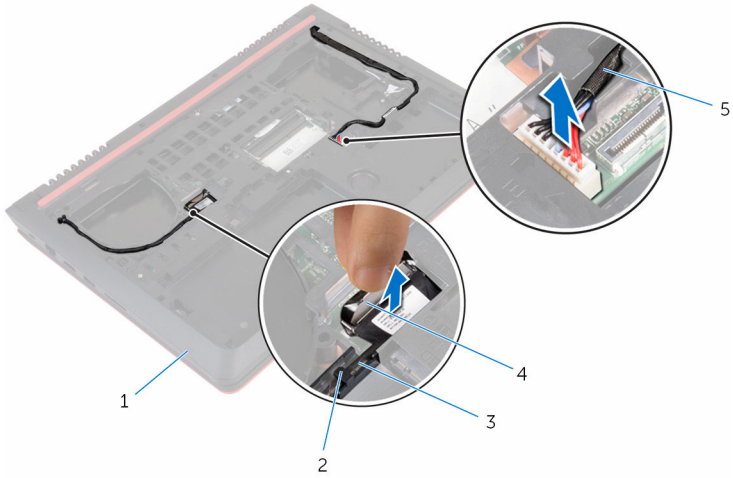

- | | | | |
|---|--------------------------|---|----------------|
| 1 | computer base | 2 | routing guides |
| 3 | display cable | 4 | pull tab |
| 5 | power-adapter port cable | | |

- 3 Turn the computer over and open the display.
- 4 Disconnect the speaker cable, I/O-board power cable, and coin-cell battery cable from the system board.
- 5 Peel the tape that secures the I/O board cable to the system board.

- 6 Open the latches and disconnect the I/O board cable and status-light board cable from the system board.

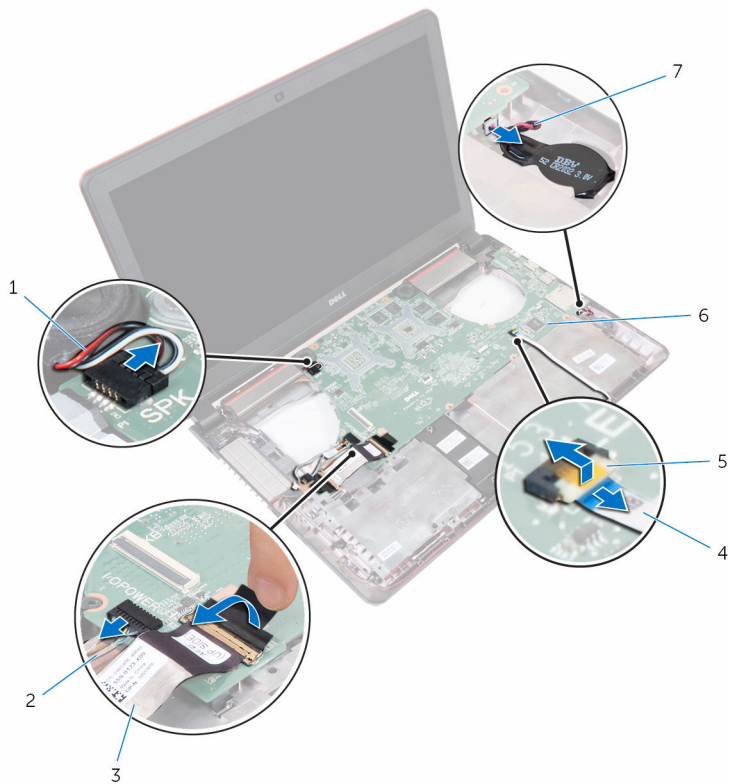

- | | | | |
|---|-------------------------|---|--------------------------|
| 1 | speaker cable | 2 | I/O-board power cable |
| 3 | I/O board cable | 4 | status-light board cable |
| 5 | latch | 6 | system board |
| 7 | coin-cell battery cable | | |

- 7 Lift the system board at an angle, slide and release the ports from the slots on the computer base.

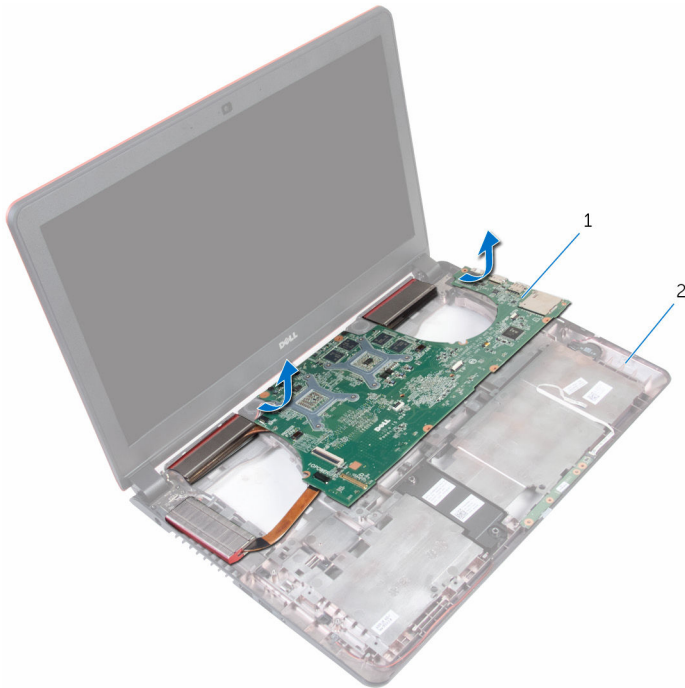

1 system board

2 computer base

- 8 Turn the system board over.
- 9 Remove the [speakers](#).
- 10 Remove the [heat sink](#).

Replacing the system board



WARNING: Before working inside your computer, read the safety information that shipped with your computer and follow the steps in [Before working inside your computer](#). After working inside your computer, follow the instructions in [After working inside your computer](#). For more safety best practices, see the Regulatory Compliance home page at www.dell.com/regulatory_compliance.



NOTE: Your computer's Service Tag is stored in the system board. You must enter the Service Tag in the BIOS setup program after you replace the system board.



NOTE: Replacing the system board removes any changes you have made to the BIOS using the BIOS setup program. You must make the desired changes again after you replace the system board.

Procedure

- 1 Replace the [heat sink](#).
- 2 Replace the [speakers](#).
- 3 Turn the system board over.
- 4 Slide the ports on the system board into the slots on the computer base and place the system board on the computer base.
- 5 Connect the speaker cable, I/O-board power cable, and coin-cell battery cable to the system board.
- 6 Slide the I/O board cable and status-light board cable into the connector on the system board and close the latches to secure the cables.
- 7 Adhere the tape that secures the I/O board cable to the system board.
- 8 Close the display and turn the computer over.
- 9 Connect the power-adaptor port cable and display cable to the system board.

Post-requisites



- 1 Replace the [fans](#).
- 2 Replace the [I/O board](#).
- 3 Follow the procedure from step 2 to step 6 in "[Replacing the palm rest](#)".

- 4 Replace the [keyboard](#).
- 5 Replace the [wireless card](#).
- 6 Replace the [memory modules](#).
- 7 Follow the procedure from step 4 to step 6 in "[Replacing the hard drive](#)".
- 8 Replace the [battery](#).
- 9 Replace the [base cover](#).

Entering the Service Tag in the BIOS setup program

- 1 Turn on the computer.
- 2 Press F2 when the DELL logo is displayed to enter the BIOS setup program.
- 3 Navigate to the **Main** tab and enter the Service Tag in the **Service Tag Input** field.

Removing the heat sink

-  **WARNING:** Before working inside your computer, read the safety information that shipped with your computer and follow the steps in [Before working inside your computer](#). After working inside your computer, follow the instructions in [After working inside your computer](#). For more safety best practices, see the Regulatory Compliance home page at www.dell.com/regulatory_compliance.
-  **WARNING:** The heat sink may become hot during normal operation. Allow sufficient time for the heat sink to cool before you touch it.
-  **CAUTION:** For maximum cooling of the processor, do not touch the heat transfer areas on the heat sink. The oils in your skin can reduce the heat transfer capability of the thermal grease.

Prerequisites

- 1 Remove the [base cover](#).
- 2 Remove the [battery](#).
- 3 Follow the procedure from step 1 to step 3 in "[Removing the hard drive](#)".
- 4 Remove the [memory modules](#).
- 5 Remove the [wireless card](#).
- 6 Remove the [keyboard](#).
- 7 Follow the procedure from step 1 to step 7 in "[Removing the palm rest](#)".
- 8 Remove the [I/O board](#).
- 9 Remove the [fans](#).
- 10 Follow the procedure from step 1 to step 7 in "[Removing the system board](#)".

Procedure

-  **NOTE:** The appearance of the heat sink on your computer may differ from the image shown in this chapter.
- 1 Place the system board on a clean and flat surface.
 - 2 In sequential order (indicated on the heat-sink), loosen the captive screws that secure the heat sink to the system board.

3 Lift the heat sink off the system board.

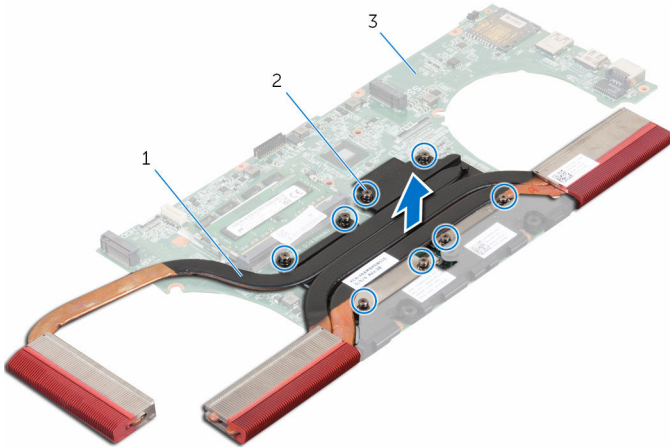



1 heat-sink

2 captive screws (7)

3 system board

Replacing the heat sink

 **WARNING:** Before working inside your computer, read the safety information that shipped with your computer and follow the steps in [Before working inside your computer](#). After working inside your computer, follow the instructions in [After working inside your computer](#). For more safety best practices, see the Regulatory Compliance home page at www.dell.com/regulatory_compliance.

 **CAUTION:** Incorrect alignment of the heat sink can cause damage to the system board and processor.

 **NOTE:** The original thermal grease can be reused if the original system board and heat sink are reinstalled together. If either the system board or the heat sink is replaced, use the thermal pad provided in the kit to ensure that thermal conductivity is achieved.

Procedure

- 1 Align the screw holes on the heat sink with the screw holes on the system board.
- 2 In sequential order (indicated on the heat-sink), tighten the captive screws that secure the heat sink to the system board.

Post-requisites

- 1 Follow the procedure from step 4 to step 8 in "[Replacing the system board](#)".
- 2 Replace the [fans](#).
- 3 Replace the [I/O board](#).
- 4 Follow the procedure from step 2 to step 6 in "[Replacing the palm rest](#)".
- 5 Replace the [keyboard](#).
- 6 Replace the [wireless card](#).
- 7 Replace the [memory modules](#).
- 8 Follow the procedure from step 4 to step 6 in "[Replacing the hard drive](#)".
- 9 Replace the [battery](#).
- 10 Replace the [base cover](#).

Removing the speakers



WARNING: Before working inside your computer, read the safety information that shipped with your computer and follow the steps in [Before working inside your computer](#). After working inside your computer, follow the instructions in [After working inside your computer](#). For more safety best practices, see the Regulatory Compliance home page at www.dell.com/regulatory_compliance.

Prerequisites

- 1 Remove the [base cover](#).
- 2 Remove the [battery](#).
- 3 Follow the procedure from step 1 to step 3 in "[Removing the hard drive](#)".
- 4 Remove the [memory modules](#).
- 5 Remove the [wireless card](#).
- 6 Remove the [keyboard](#).
- 7 Follow the procedure from step 1 to step 7 in "[Removing the palm rest](#)".
- 8 Remove the [I/O board](#).
- 9 Remove the [fans](#).
- 10 Follow the procedure from step 1 to step 7 in "[Removing the system board](#)".

Procedure

- 1 Note the position of the rubber grommets before lifting the speaker.

2 Lift the speaker at an angle off the system board.

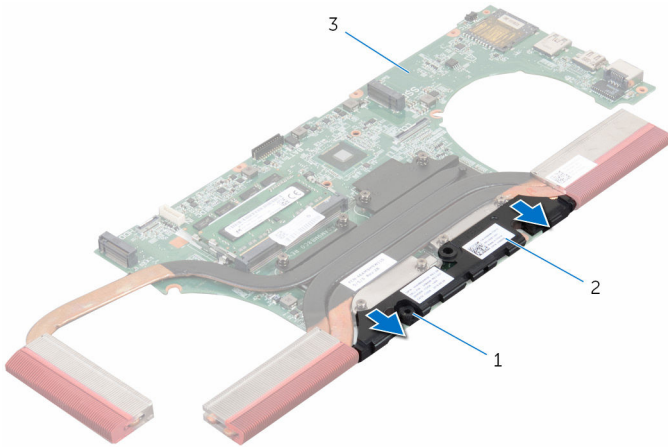

1 rubber grommets (3)

2 speakers

3 system board

Replacing the speakers



WARNING: Before working inside your computer, read the safety information that shipped with your computer and follow the steps in [Before working inside your computer](#). After working inside your computer, follow the instructions in [After working inside your computer](#). For more safety best practices, see the Regulatory Compliance home page at www.dell.com/regulatory_compliance.

Procedure



NOTE: The rubber grommets may get pushed out while replacing the speaker. Ensure that the rubber grommets are in their position after placing the speaker on the system board.

- 1 Using the alignment posts, align and place the speaker on the system board.
- 2 Replace the rubber grommets if they are pushed up while replacing the speaker.

Post-requisites

- 1 Follow the procedure from step 4 to step 8 in "[Replacing the system board](#)".
- 2 Replace the [fans](#).
- 3 Replace the [I/O board](#).
- 4 Follow the procedure from step 2 to step 6 in "[Replacing the palm rest](#)".
- 5 Replace the [keyboard](#).
- 6 Replace the [wireless card](#).
- 7 Replace the [memory modules](#).
- 8 Follow the procedure from step 4 to step 6 in "[Replacing the hard drive](#)".
- 9 Replace the [battery](#).
- 10 Replace the [base cover](#).

Removing the subwoofer



WARNING: Before working inside your computer, read the safety information that shipped with your computer and follow the steps in [Before working inside your computer](#). After working inside your computer, follow the instructions in [After working inside your computer](#). For more safety best practices, see the Regulatory Compliance home page at www.dell.com/regulatory_compliance.

Prerequisites

- 1 Remove the [base cover](#).
- 2 Remove the [battery](#).
- 3 Follow the procedure from step 1 to step 3 in "[Removing the hard drive](#)".
- 4 Remove the [memory modules](#).
- 5 Remove the [wireless card](#).
- 6 Remove the [keyboard](#).
- 7 Follow the procedure from step 1 to step 7 in "[Removing the palm rest](#)".
- 8 Remove the [I/O board](#).
- 9 Remove the [fans](#).
- 10 Follow the procedure from step 1 to step 7 in "[Removing the system board](#)".

Procedure

- 1 Note the sub-woofer cable routing and remove it from the routing guides on the computer base.
- 2 Note the position of the rubber grommets before lifting the sub woofer.

3 Lift the sub woofers off the computer base.

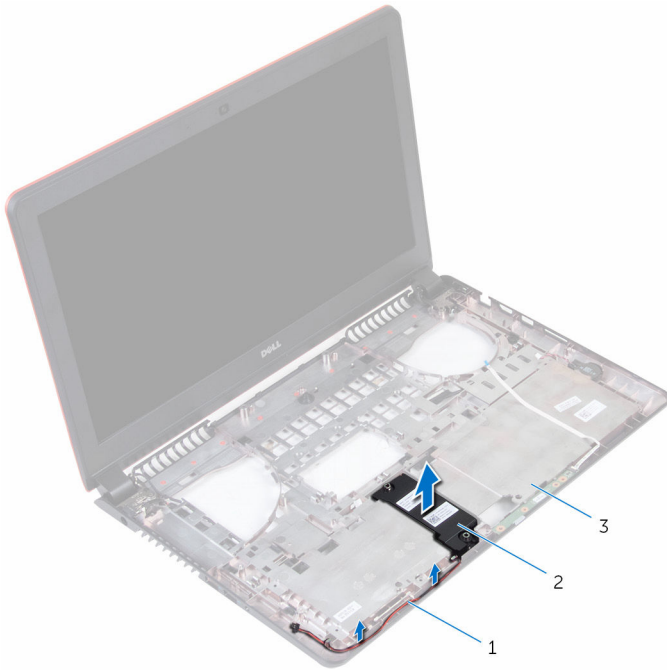

1 sub-woofer cable

2 sub woofer

3 computer base

Replacing the subwoofer

 **WARNING:** Before working inside your computer, read the safety information that shipped with your computer and follow the steps in [Before working inside your computer](#). After working inside your computer, follow the instructions in [After working inside your computer](#). For more safety best practices, see the Regulatory Compliance home page at www.dell.com/regulatory_compliance.

Procedure

 **NOTE:** The rubber grommets may get pushed out while replacing the sub woofers. Ensure that the rubber grommets are in their position after placing the sub woofers on the computer base.

- 1 Using the alignment posts, align and place the sub woofers on the computer base.
- 2 Route the sub-woofer cable through the routing guides on the computer base.
- 3 Replace the rubber grommets if they are pushed up while replacing the sub woofers.

Post-requisites

- 1 Follow the procedure from step 4 to step 8 in "[Replacing the system board](#)".
- 2 Replace the [fans](#).
- 3 Replace the [I/O board](#).
- 4 Follow the procedure from step 2 to step 6 in "[Replacing the palm rest](#)".
- 5 Replace the [keyboard](#).
- 6 Replace the [wireless card](#).
- 7 Replace the [memory modules](#).
- 8 Follow the procedure from step 4 to step 6 in "[Replacing the hard drive](#)".
- 9 Replace the [battery](#).
- 10 Replace the [base cover](#).

Removing the power-adapter port

 **WARNING:** Before working inside your computer, read the safety information that shipped with your computer and follow the steps in [Before working inside your computer](#). After working inside your computer, follow the instructions in [After working inside your computer](#). For more safety best practices, see the Regulatory Compliance home page at www.dell.com/regulatory_compliance.

Prerequisites

- 1 Remove the [base cover](#).
- 2 Remove the [battery](#).
- 3 Follow the procedure from step 1 to step 3 in "[Removing the hard drive](#)".
- 4 Remove the [keyboard](#).
- 5 Follow the procedure from step 1 to step 7 in "[Removing the palm rest](#)".
- 6 Follow the procedure from step 1 to step 3 in "[Removing the fans](#)".

Procedure

- 1 Disconnect the power-adapter port cable from the system board.
- 2 Note the power-adapter port cable routing and remove it from the routing guides on the computer base.

- 3** Slide the power-adapter port cable through the slot on the computer base.

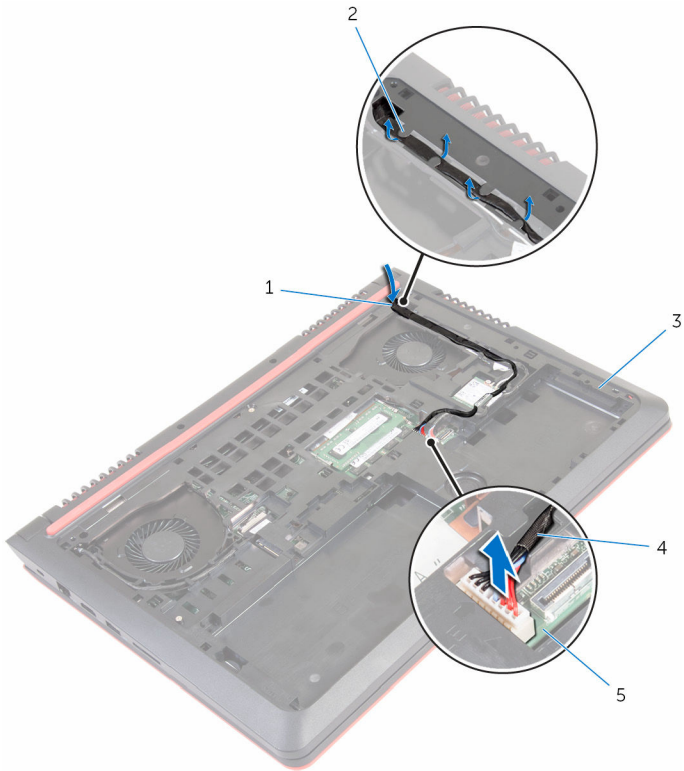

1 slot

3 computer base

5 system board

2 routing guides

4 power-adapter port cable

- 4** Turn the computer over.

- 5 Lift the power-adapter port along with its cable off the computer base.

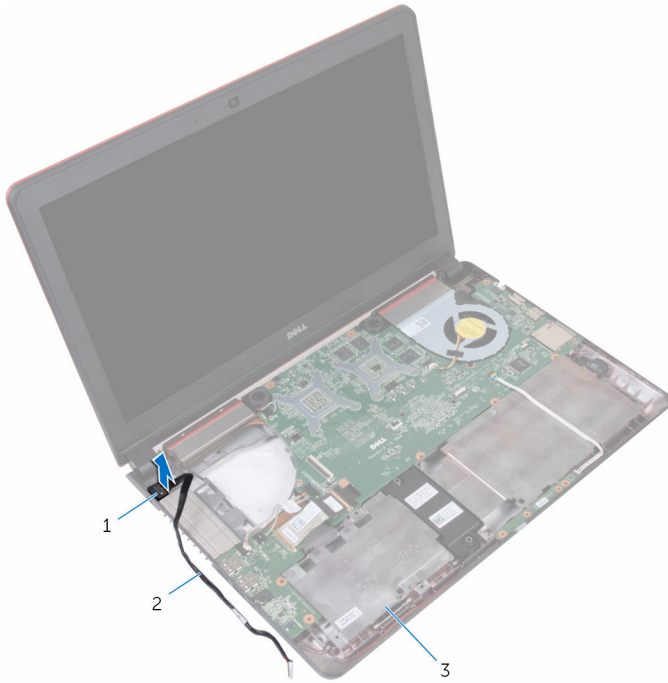

1 power-adapter port

2 power-adapter port cable

3 computer base

Replacing the power-adapter port

 **WARNING:** Before working inside your computer, read the safety information that shipped with your computer and follow the steps in [Before working inside your computer](#). After working inside your computer, follow the instructions in [After working inside your computer](#). For more safety best practices, see the Regulatory Compliance home page at www.dell.com/regulatory_compliance.

Procedure

- 1 Insert the power-adapter port into the slot on the computer base.
- 2 Slide the power-adapter port cable through the slot on the computer base.
- 3 Turn the computer over.
- 4 Route the power-adapter port cable through the routing guides on the computer base.
- 5 Connect the power-adapter port cable to the system board.

Post-requisites

- 1 Follow the procedure from step 1 to step 3 in "[Replacing the fans](#)".
- 2 Follow the procedure from step 2 to step 6 in "[Replacing the palm rest](#)".
- 3 Replace the [keyboard](#).
- 4 Follow the procedure from step 4 to step 6 in "[Replacing the hard drive](#)".
- 5 Replace the [base cover](#).
- 6 Replace the [battery](#).

Removing the display assembly

 **WARNING:** Before working inside your computer, read the safety information that shipped with your computer and follow the steps in [Before working inside your computer](#). After working inside your computer, follow the instructions in [After working inside your computer](#). For more safety best practices, see the Regulatory Compliance home page at www.dell.com/regulatory_compliance.

Prerequisites

- 1 Remove the [battery](#).
- 2 Remove the [base cover](#).
- 3 Follow the procedure from step 1 to step 3 in "[Removing the hard drive](#)".
- 4 Remove the [keyboard](#).
- 5 Follow the procedure from step 1 to step 7 in "[Removing the palm rest](#)".
- 6 Remove the [fans](#).

Procedure

- 1 Close the display and turn the computer over.
- 2 Using the pull tab, disconnect the display cable from the system board.
- 3 Note the display-cable routing and remove the cable from the routing guides on the computer base.
- 4 Disconnect the antenna cables from the wireless card.
- 5 Note the antenna-cable routing and remove the antenna cables from the routing guides on the computer base.

- 6 Slide the display cable and antenna cables through the slots on the computer base.

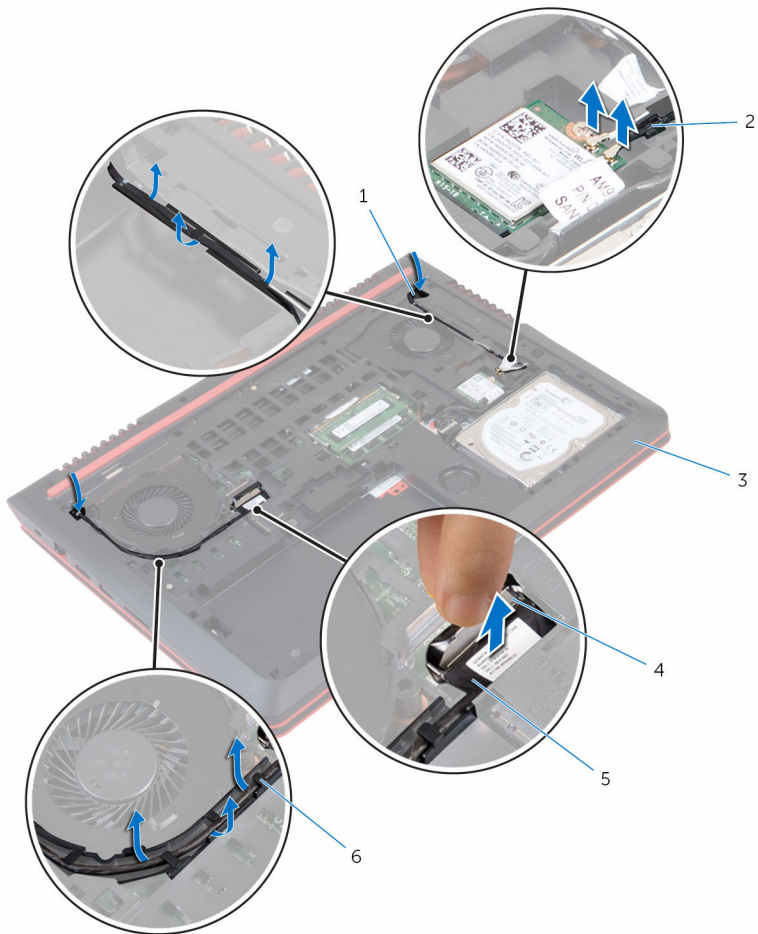

- | | | | |
|---|---------------|---|--------------------|
| 1 | slots (2) | 2 | antenna cables (2) |
| 3 | computer base | 4 | pull tab |
| 5 | display cable | 6 | routing guides |

- 7 Remove the screws that secure the display assembly to the computer base.

8 Lift the display assembly off the computer base.

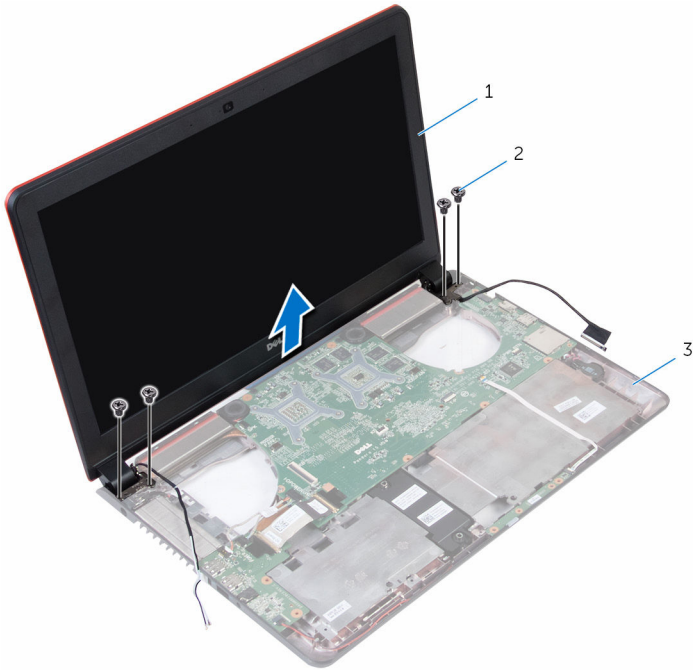

1 display assembly

2 screws (4)

3 computer base

Replacing the display assembly



WARNING: Before working inside your computer, read the safety information that shipped with your computer and follow the steps in [Before working inside your computer](#). After working inside your computer, follow the instructions in [After working inside your computer](#). For more safety best practices, see the Regulatory Compliance home page at www.dell.com/regulatory_compliance.

Procedure

- 1 Align the screw holes on the display assembly with the screw holes on the computer base.
- 2 Replace the screws that secure the display assembly to the computer base.
- 3 Slide the display cable and antenna cables through the slot on the computer base.
- 4 Route the display cable and antenna cables through the routing guides on the computer base.
- 5 Connect the antenna cables to the wireless card.
- 6 Connect the display cable to the system board.
- 7 Close the display and turn the computer over.

Post-requisites

- 1 Replace the [fans](#).
- 2 Follow the procedure from step 2 to step 6 in "[Replacing the palm rest](#)".
- 3 Replace the [keyboard](#).
- 4 Follow the procedure from step 4 to step 6 in "[Replacing the hard drive](#)".
- 5 Replace the [base cover](#).
- 6 Replace the [battery](#).

Removing the display bezel



WARNING: Before working inside your computer, read the safety information that shipped with your computer and follow the steps in [Before working inside your computer](#). After working inside your computer, follow the instructions in [After working inside your computer](#). For more safety best practices, see the Regulatory Compliance home page at www.dell.com/regulatory_compliance.

Prerequisites



NOTE: These instructions are applicable only for laptops with a non-touch screen display.

- 1 Remove the [battery](#).
- 2 Remove the [base cover](#).
- 3 Follow the procedure from step 1 to step 3 in "[Removing the hard drive](#)".
- 4 Remove the [keyboard](#).
- 5 Follow the procedure from step 1 to step 7 in "[Removing the palm rest](#)".
- 6 Remove the [fans](#).
- 7 Remove the [display assembly](#).

Procedure

- 1 Using your fingertips, gently pry up the inner edges of the display bezel.

2 Lift the display bezel off the display assembly.

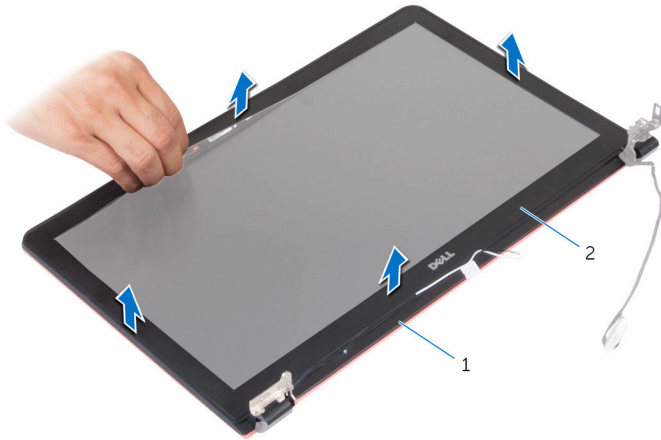

1 display back-cover

2 display bezel

Replacing the display bezel



WARNING: Before working inside your computer, read the safety information that shipped with your computer and follow the steps in [Before working inside your computer](#). After working inside your computer, follow the instructions in [After working inside your computer](#). For more safety best practices, see the Regulatory Compliance home page at www.dell.com/regulatory_compliance.

Procedure

Align the display bezel with the display back-cover and gently snap the display bezel into place.

Post-requisites

- 1 Replace the [display assembly](#).
- 2 Replace the [fans](#).
- 3 Follow the procedure from step 2 to step 6 in "[Replacing the palm rest](#)".
- 4 Replace the [keyboard](#).
- 5 Follow the procedure from step 4 to step 6 in "[Replacing the hard drive](#)".
- 6 Replace the [base cover](#).
- 7 Replace the [battery](#).

Removing the display panel



WARNING: Before working inside your computer, read the safety information that shipped with your computer and follow the steps in [Before working inside your computer](#). After working inside your computer, follow the instructions in [After working inside your computer](#). For more safety best practices, see the Regulatory Compliance home page at www.dell.com/regulatory_compliance.

Prerequisites



NOTE: These instructions are applicable only for laptops with a non-touch screen display.

- 1 Remove the [battery](#).
- 2 Remove the [base cover](#).
- 3 Follow the procedure from step 1 to step 3 in "[Removing the hard drive](#)".
- 4 Remove the [keyboard](#).
- 5 Follow the procedure from step 1 to step 7 in "[Removing the palm rest](#)".
- 6 Remove the [fans](#).
- 7 Remove the [display assembly](#).
- 8 Remove the [display bezel](#).

Procedure

- 1 Remove the screws that secure the display panel to the display back-cover.

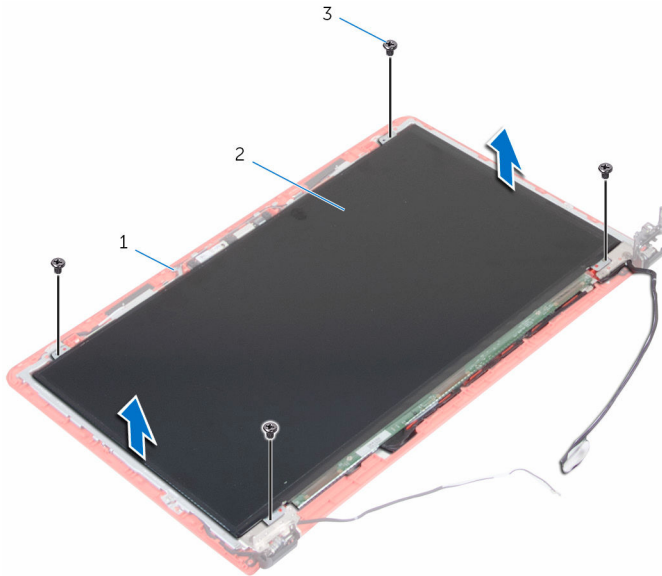

1 display back-cover

2 display panel

3 screws (4)

- 2 Turn the display panel over.
- 3 Peel the tape that secures the display cable to the display-back cover.
- 4 Open the latch and disconnect the display cable from the display-back cover.

5 Lift the display panel off the display back-cover.

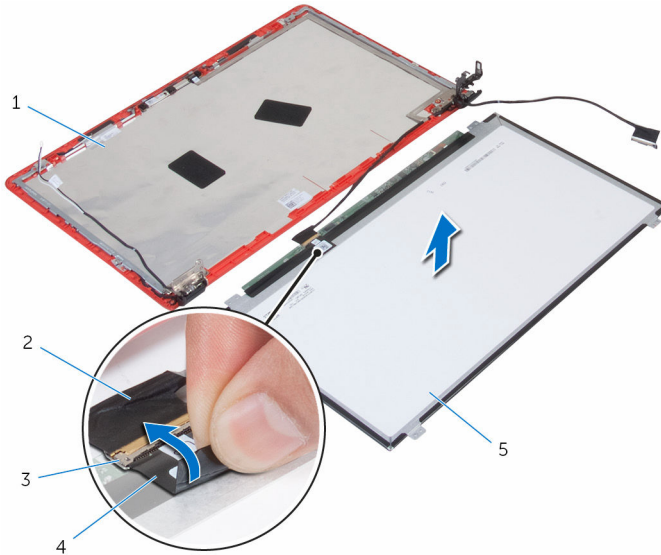

1 display back-cover

2 display cable

3 latch

4 tape

5 display panel

Replacing the display panel



WARNING: Before working inside your computer, read the safety information that shipped with your computer and follow the steps in [Before working inside your computer](#). After working inside your computer, follow the instructions in [After working inside your computer](#). For more safety best practices, see the Regulatory Compliance home page at www.dell.com/regulatory_compliance.

Procedure

- 1 Slide the display cable into the connector on the display back-cover and close the latch to secure the cable.
- 2 Adhere the tape that secures the display cable to the display back-cover.
- 3 Turn the display panel over and place it on the display back-cover.
- 4 Align the screw holes on the display panel with the screw holes on the display back-cover.
- 5 Replace the screws that secure the display panel to the display back-cover.

Post-requisites

- 1 Replace the [display bezel](#).
- 2 Replace the [display assembly](#).
- 3 Replace the [fans](#).
- 4 Follow the procedure from step 2 to step 6 in "[Replacing the palm rest](#)".
- 5 Replace the [keyboard](#).
- 6 Follow the procedure from step 4 to step 6 in "[Replacing the hard drive](#)".
- 7 Replace the [base cover](#).
- 8 Replace the [battery](#).

Removing the display hinge and bracket assembly

 **WARNING:** Before working inside your computer, read the safety information that shipped with your computer and follow the steps in [Before working inside your computer](#). After working inside your computer, follow the instructions in [After working inside your computer](#). For more safety best practices, see the Regulatory Compliance home page at www.dell.com/regulatory_compliance.

Prerequisites

 **NOTE:** These instructions are applicable only for laptops with a non-touch screen display.

- 1 Remove the [battery](#).
- 2 Remove the [base cover](#).
- 3 Follow the procedure from step 1 to step 3 in "[Removing the hard drive](#)".
- 4 Remove the [keyboard](#).
- 5 Follow the procedure from step 1 to step 7 in "[Removing the palm rest](#)".
- 6 Remove the [fans](#).
- 7 Remove the [display assembly](#).
- 8 Remove the [display bezel](#).
- 9 Remove the [display panel](#).

Procedure

- 1 Note the antenna-cable routing and remove the antenna cables from the routing guides on the display hinges.
- 2 Note the display cable routing and remove the display cable from the routing guides on the display hinges.
- 3 Remove the screws that secure the display hinges to the display back-cover.

- 4 Release the hinges from the latches and lift the display hinges off the display back-cover.

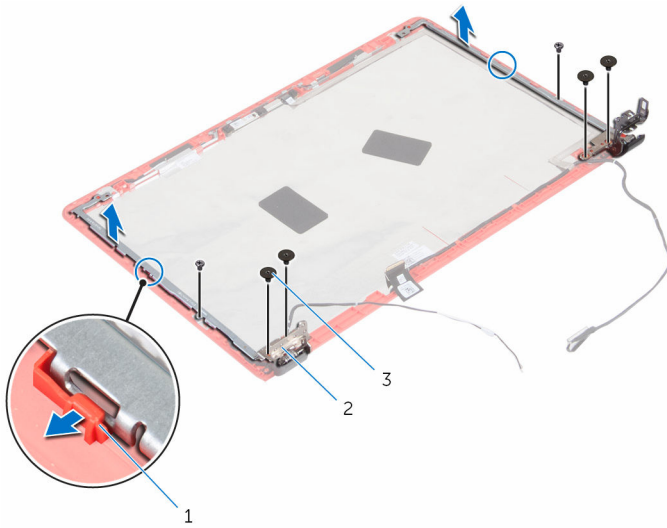

1 latches

2 display hinges (2)

3 screws (6)

Replacing the display hinge and bracket assembly



WARNING: Before working inside your computer, read the safety information that shipped with your computer and follow the steps in [Before working inside your computer](#). After working inside your computer, follow the instructions in [After working inside your computer](#). For more safety best practices, see the Regulatory Compliance home page at www.dell.com/regulatory_compliance.

Procedure

- 1 Slide the hinges under the latches on the display back-cover.
- 2 Align the screw holes on the display hinges with the screw holes on the display back-cover.
- 3 Replace the screws that secure the display hinges to the display back-cover.
- 4 Route the antenna cable and display cable through the routing guides on the display hinges.

Post-requisites

- 1 Replace the [display panel](#).
- 2 Replace the [display bezel](#).
- 3 Replace the [display assembly](#).
- 4 Replace the [fans](#).
- 5 Follow the procedure from step 2 to step 6 in "[Replacing the palm rest](#)".
- 6 Replace the [keyboard](#).
- 7 Follow the procedure from step 4 to step 6 in "[Replacing the hard drive](#)".
- 8 Replace the [base cover](#).
- 9 Replace the [battery](#).

Removing the camera



WARNING: Before working inside your computer, read the safety information that shipped with your computer and follow the steps in [Before working inside your computer](#). After working inside your computer, follow the instructions in [After working inside your computer](#). For more safety best practices, see the Regulatory Compliance home page at www.dell.com/regulatory_compliance.

Prerequisites



NOTE: These instructions are applicable only for laptops with a non-touch screen display.

- 1 Remove the [battery](#).
- 2 Remove the [base cover](#).
- 3 Follow the procedure from step 1 to step 3 in "[Removing the hard drive](#)".
- 4 Remove the [keyboard](#).
- 5 Follow the procedure from step 1 to step 7 in "[Removing the palm rest](#)".
- 6 Remove the [fans](#).
- 7 Remove the [display assembly](#).
- 8 Remove the [display bezel](#).
- 9 Remove the [display panel](#).

Procedure

- 1 Using a plastic scribe, gently pry the camera from the display back-cover and turn it over.
- 2 Peel off the tape that secures the camera cable to the camera.

3 Turn the camera over and disconnect the camera cable from the camera.

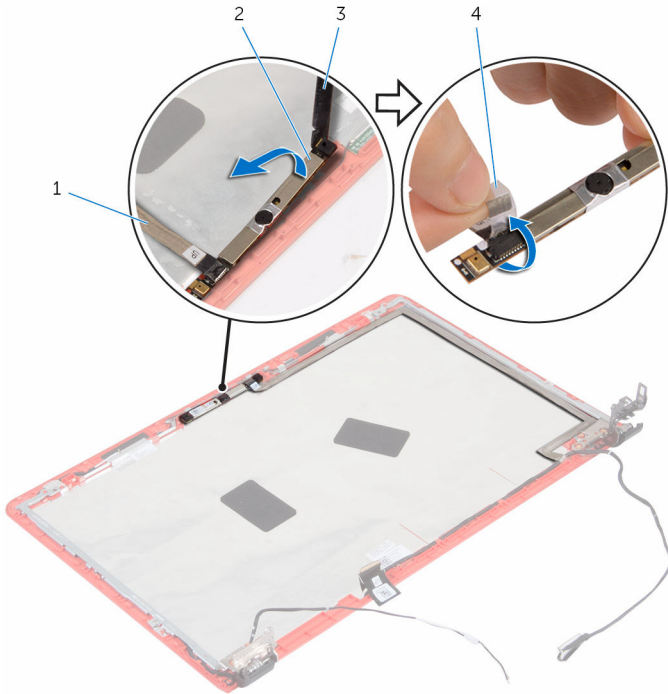

1 camera cable

2 camera

3 plastic scribe

4 tape

Replacing the camera



WARNING: Before working inside your computer, read the safety information that shipped with your computer and follow the steps in [Before working inside your computer](#). After working inside your computer, follow the instructions in [After working inside your computer](#). For more safety best practices, see the Regulatory Compliance home page at www.dell.com/regulatory_compliance.

Procedure

- 1 Connect the camera cable to the camera.
- 2 Adhere the tape that secures the camera cable to the camera.
- 3 Turn the camera over and align the camera to the alignment posts on the display back-cover and snap the camera in place.

Post-requisites

- 1 Replace the [display panel](#).
- 2 Replace the [display bezel](#).
- 3 Replace the [display assembly](#).
- 4 Replace the [fans](#).
- 5 Follow the procedure from step 2 to step 6 in "[Replacing the palm rest](#)".
- 6 Replace the [keyboard](#).
- 7 Follow the procedure from step 4 to step 6 in "[Replacing the hard drive](#)".
- 8 Replace the [base cover](#).
- 9 Replace the [battery](#).

Flashing the BIOS

You may need to flash (update) the BIOS when an update is available or when you replace the system board. To flash the BIOS:

- 1 Turn on the computer.
- 2 Go to **www.dell.com/support**.
- 3 Click **Product Support**, enter the Service Tag of your computer and click **Submit**.
 **NOTE:** If you do not have the Service Tag, use the auto-detect feature or manually browse for your computer model.
- 4 Click **Drivers & downloads**.
- 5 Select the operating system installed on your computer.
- 6 Scroll down the page and expand **BIOS**.
- 7 Click **Download File** to download the latest version of the BIOS for your computer.
- 8 Save the file and, once the download is complete, navigate to the folder where you saved the BIOS update file.
- 9 Double-click the BIOS update file icon and follow the instructions on the screen.

Getting help and contacting Dell

Self-help resources

You can get information and help on Dell products and services using these self-help resources:

Information about Dell products and services

www.dell.com

Windows 8.1 and Windows 10

Dell Help & Support app



Windows 10

Get started app



Windows 8.1

Help + Tips app



Accessing help in Windows 8, Windows 8.1, and Windows 10

In Windows search, type **Help and Support**, and press **Enter**.

Accessing help in Windows 7

Click **Start** → **Help and Support**.

Online help for operating system

www.dell.com/support/windows
www.dell.com/support/linux

Troubleshooting information, user manuals, setup instructions, product specifications, technical help blogs, drivers, software updates, and so on

www.dell.com/support

Learn about your operating system, setting up and using your computer, data backup, diagnostics, and so on.

See *Me and My Dell* at www.dell.com/support/manuals.

Contacting Dell

To contact Dell for sales, technical support, or customer service issues, see www.dell.com/contactdell.



NOTE: Availability varies by country and product, and some services may not be available in your country.



NOTE: If you do not have an active internet connection, you can find contact information on your purchase invoice, packing slip, bill, or Dell product catalog.